

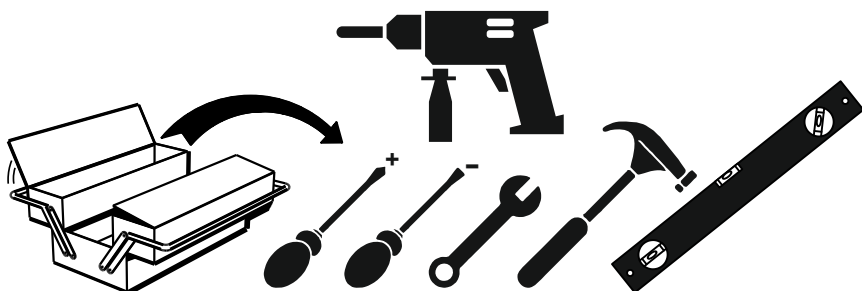

MULTIMO

217-ROYAL SINGLE WARDROBE

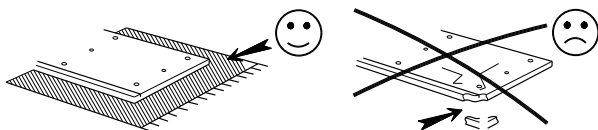

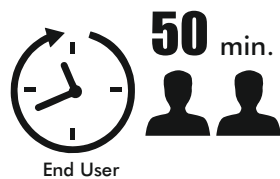
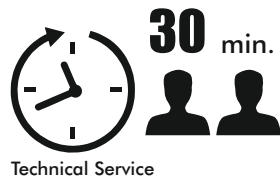
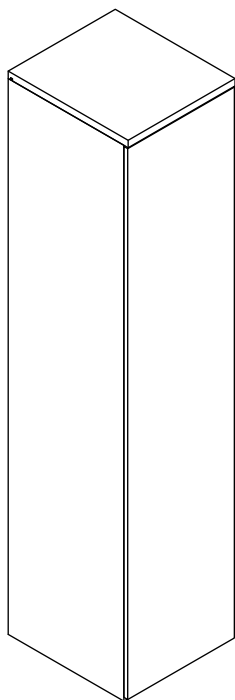

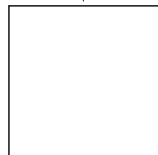





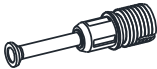

VIDEO

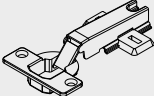
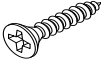
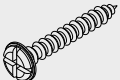
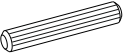
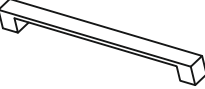

link

Track Title	Piece	(inch)			(mm)			
		Thickness	Length	Width	Piece	Thick	Height	Most
A		0,71	88,58	21,26	2	18	2250	540
B		1,18	19,69	22,05	1	30	500	560
C		1,18	18,27	21,26	1	30	464	540
D		0,71	18,27	20,47	1	18	464	520
E		0,71	18,27	19,69	3	18	464	500
F		0,71	87,48	19,61	1	18	2222	498
G		0,31	88,03	18,94	1	8	2236	481

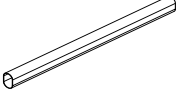
Accessories List

MXN 02  12 / piece	MNG - 01  12 / piece	PM - 01  12 / piece	TAP - 01  12 / piece
TS - 01  4 / piece	VD - 03 (3,5x18) mm  20 / piece	VD - 02 (3,5x25) mm  6 / piece	KVL 01  12 / piece
KP - 01 (224) mm  1 / piece	AF - 02  2 / piece	VKP - 03 (22) mm  2 / piece	BRK - 01  2 / piece
VTB - 01 (4,8x16) mm  8 / piece	BO - 01  1 / piece	AVT - 01  4 / piece	TSY - 01  2 / piece

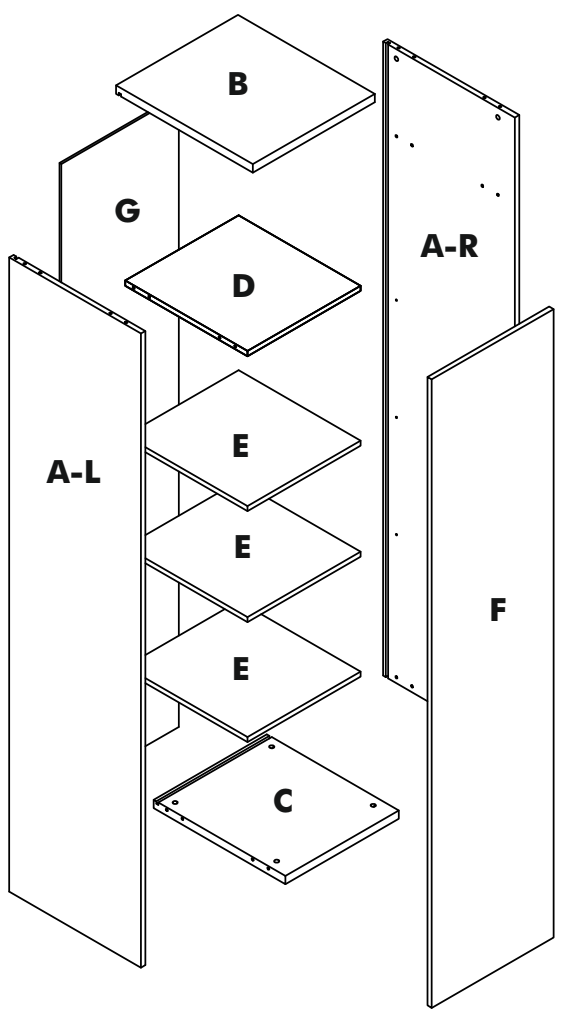

STEP 1



MNX - 02

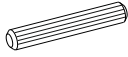

KVL 01

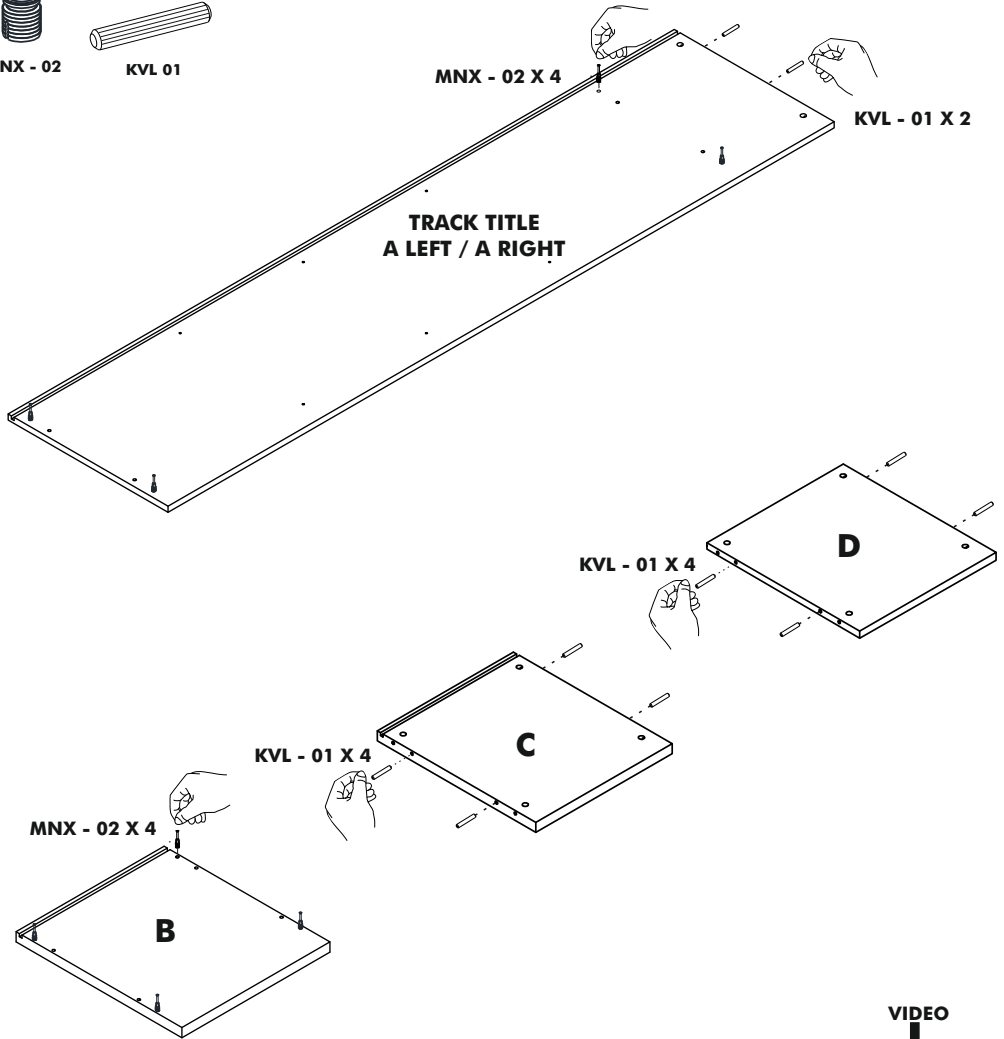

VIDEO

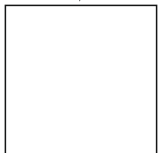

link

STEP 2

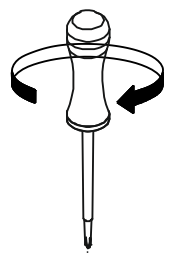
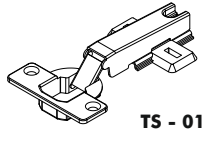

VD - 03 X 8

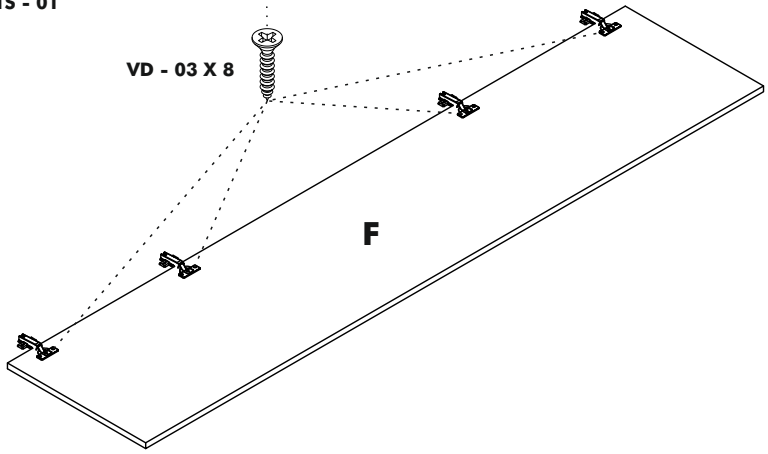

STEP 3

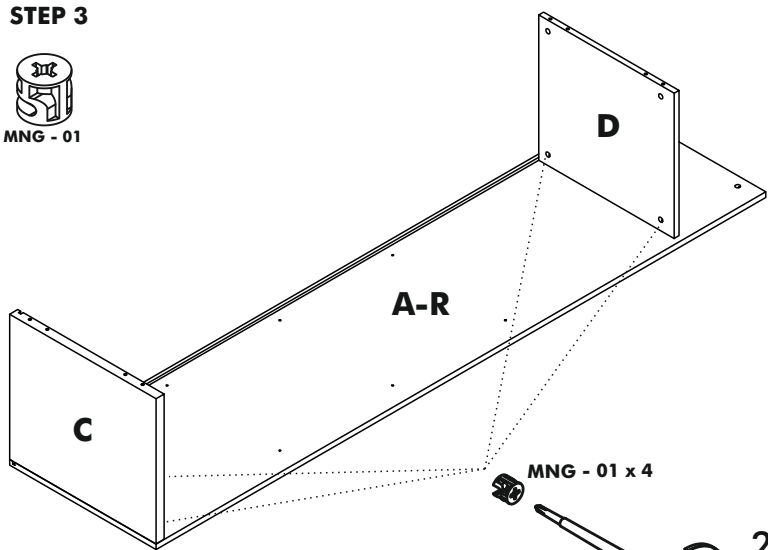

VIDEO

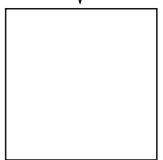

link

STEP 4

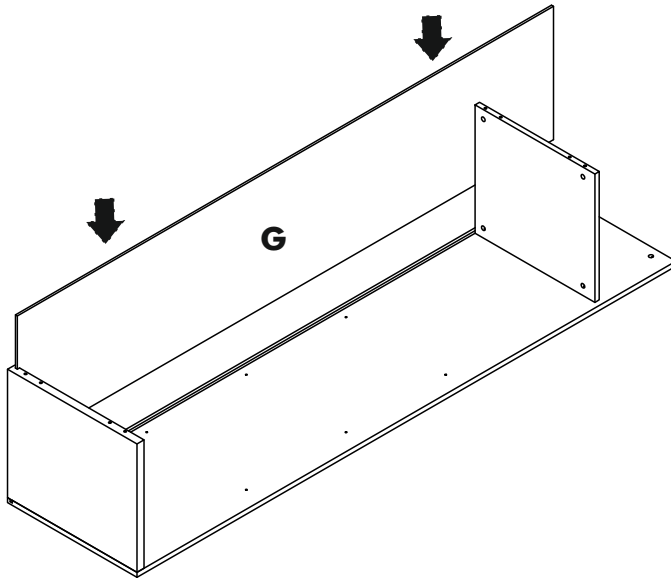

STEP 5

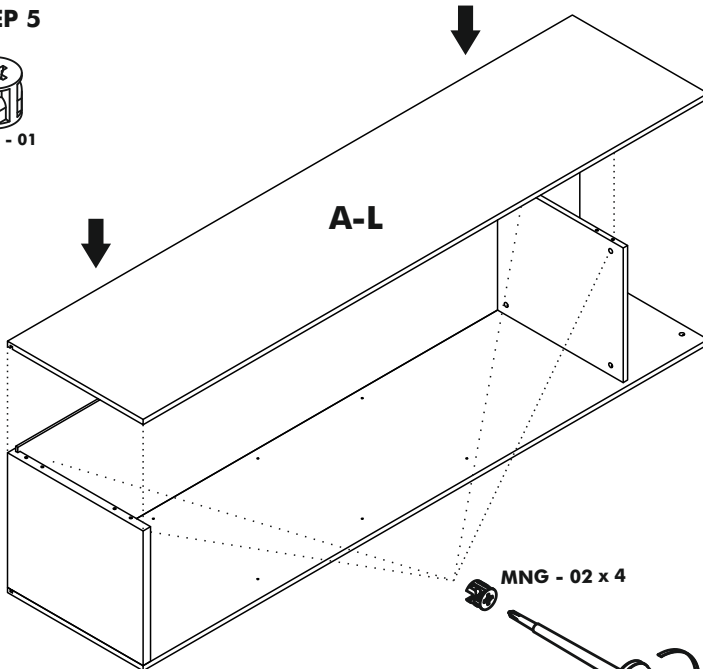

VIDEO

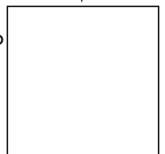

link

STEP 6

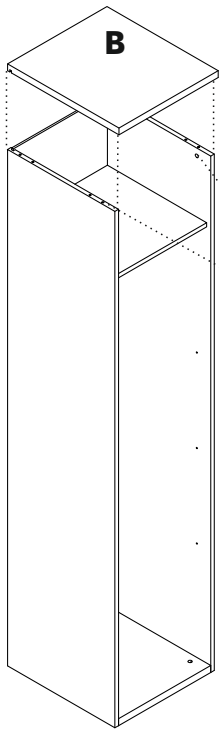

MNG - 02 x 4



STEP 7

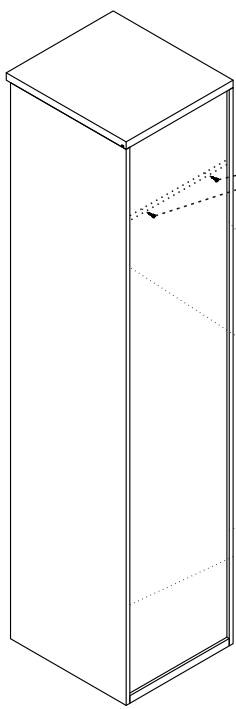

VD - 02 x 2



AVT - 01 x 4



VD - 02 x 4



VIDEO

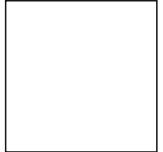

STEP 8-1

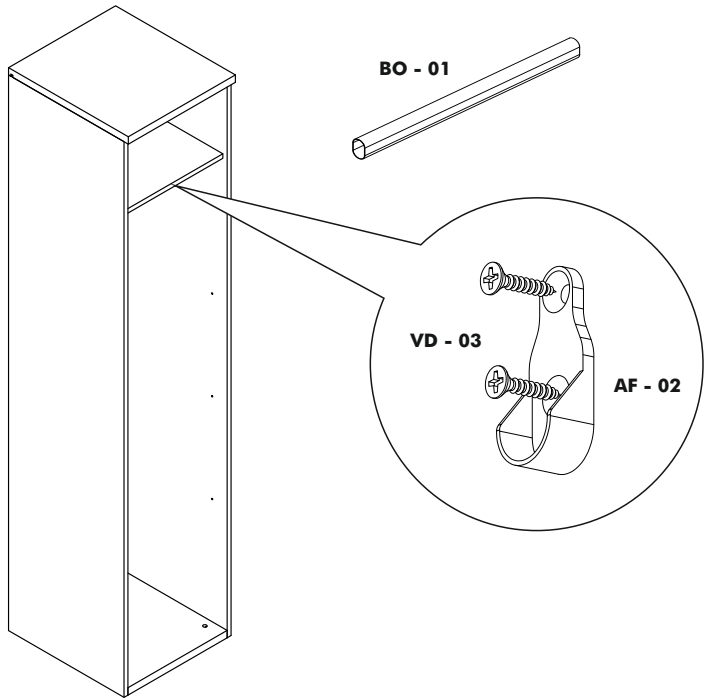

STEP 8-2

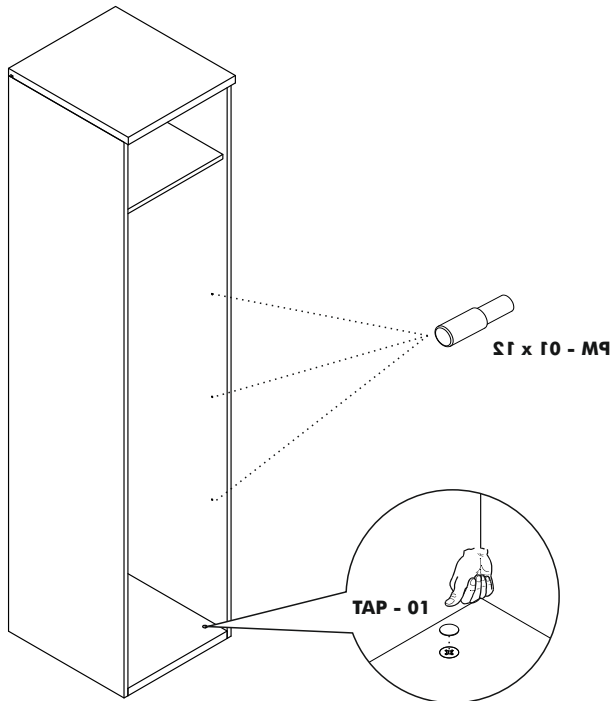

VIDEO

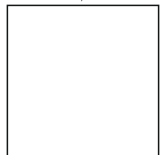

link

STEP 9

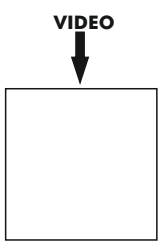
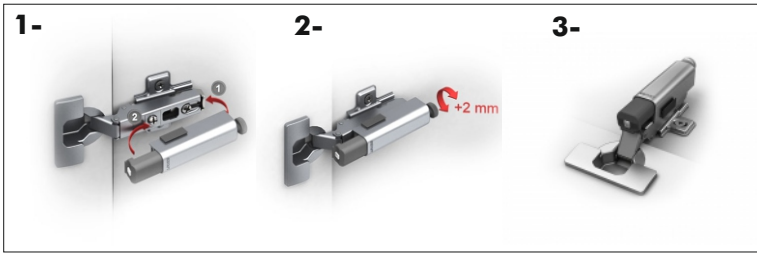
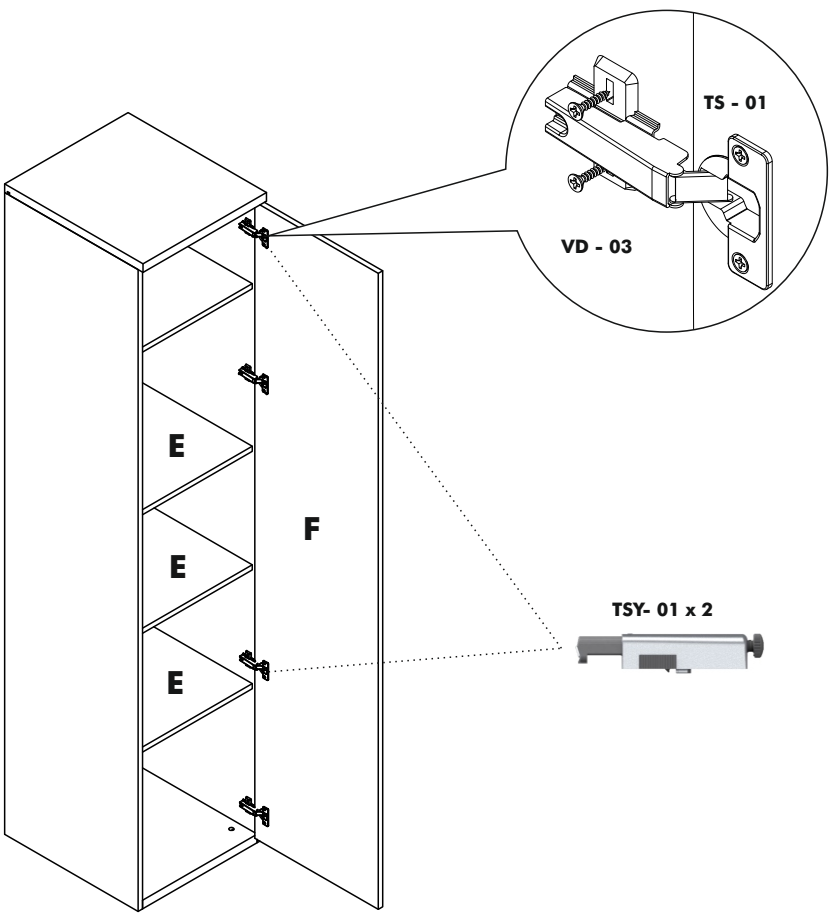

STEP 10

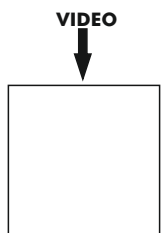
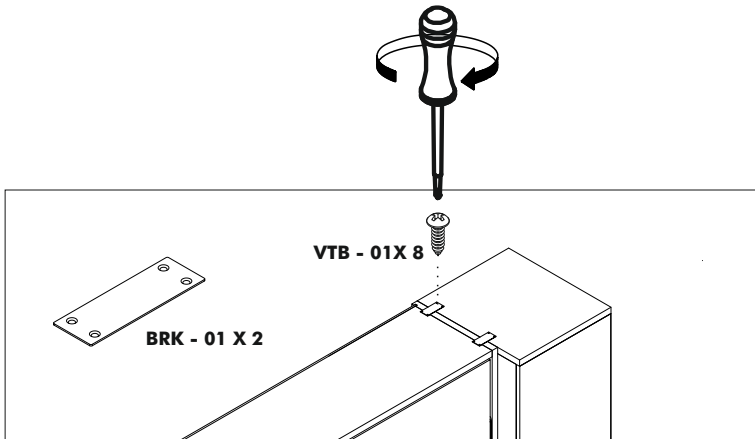
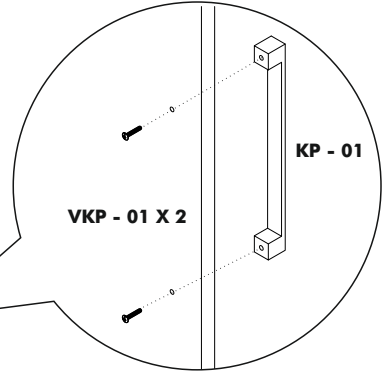
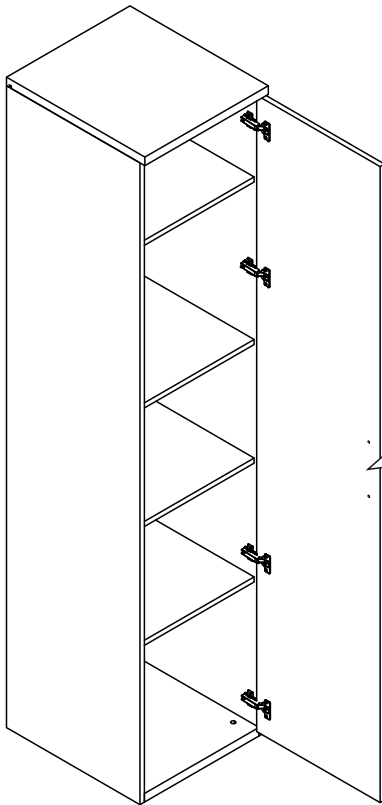

ATTENTION / HOW TO / READ ME / OWNER'S GUIDE

1. When mounting on a regular drywall, furniture must be fastened to wood or metal studs. Solid walls made of brick, concrete or similar strong material are also acceptable. Do not mount furniture to paper-mache or sheet rock like material without properly attaching to stud.
2. For safety and product longevity you must periodically inspect the mounting and mechanical connections for integrity and tightness. Confirm hardware remains properly affixed and connections snug.
3. Wall Bed mattress thickness may not exceed 8 inch. Take care to remove pillows and excess blankets before closing. Doing so keeps mechanism free of obstruction and unnecessary stress.
4. Do not lean or rest heavy objects on side or top of furniture. This may cause balance issues and compromise the integrity of your mounting connections.
5. Please use the furniture's beds, desks and shelving as intended. Not designed to be sat, stood, leaned, jumped (etc) on. Improper use may cause personal injury and damage to property.
6. With seasonal humidity change you must inspect interior and exterior of furniture.
7. Single, Twin, Twin XL beds accommodate the weight of one person. Improperly sleeping more than one person risks injury to person and damage to property.
8. Before any un-mounting or disassembly please contact Multimo for technical support and instruction. Failure to properly detach risks injury to person and damage to property.
9. For Bunk Beds:
 - a. Always use provided ladder when accessing top bunk.
 - b. Be slow, careful and aware of surroundings when opening top bunk.
 - c. Do not horseplay. Beds are to be slept on only.
 - d. Some have legs that fully extend when open- be aware of where the leg is and will be.



MULTiMO

www.multimo.com